

ARTICLE

Design of Digital Solar Water Pump Using Microcontroller ATmega 32

Rajesh Shrestha^{1*} Arun Raj Dhakal¹ Saroj Thakur¹ Dipak Subedi² Mahesh Sharma¹

1. Tri-Chandra Multiple College, Ghantaghar, Nepal

2. Patan Multiple College, Patan, Nepal

ARTICLE INFO

Article history

Received: 05 August 2022

Revised: 19 September 2022

Accepted: 25 September 2022

Published Online: 19 October 2022

Keywords:

Solar PV array

LDR sensor

Water flow sensors

Arduino Uno and Liquid

Crystal display

ABSTRACT

This paper focuses on the application of solar energy along with microcontrollers to design and run a motor to pump water from various sources. The solar water pump is one of the applications or appliance that perform task with the use of solar radiation. The solar water pump consists of solar PV array, solar pump, inverter, AC water pumping device etc. Solar energy radiation is converted in electrical current or power source which is then used to run a pump and draw water directly from ground, wells, rivers, lakes etc. In this paper, the relationship between flow rate of the water and luminous intensity of the solar irradiance is studied and the data are linearly fitted to find out the correlation between these parameters. Also the study about efficiency of the solar powered water pump shows that the operation of this type of pumping system is quite efficient than other types of fossil fuel engines like diesel, petrol, kerosene etc. in long run. The use of Arduino Uno, flow sensor, LDR sensors in the solar powered water pump helps to analyze the relation between these parameters and know the conditions favorable for excess supply of water in short time efficiently. These solar powered devices are the future of clean and green future of this world. Thus it is not only necessary but also compulsory to enhance the usage of solar energy throughout the globe.

1. Introduction

1.1 General Introduction

The most abundant source of energy available on earth is solar energy. Solar energy is most essential source of energy for the living creatures on this planet. Also for

several physical and chemical changes usually occurs on the earth also uses solar energy. It is the free energy which can be converted into other form of energies and perform several task. This energy is inevitable source of energy as life is not possible without it. The bad impact of continuous consumption of fossil fuel on the environment encouraged the scientist to switch over the renewable

*Corresponding Author:

Rajesh Shrestha,

Tri-Chandra Multiple College, Ghantaghar, Nepal;

Email: rajeshshrestha402@gmail.com

DOI: <https://doi.org/10.30564/ese.v4i2.4945>

Copyright © 2022 by the author(s). Published by Bilingual Publishing Co. This is an open access article under the Creative Commons Attribution-NonCommercial 4.0 International (CC BY-NC 4.0) License. (<https://creativecommons.org/licenses/by-nc/4.0/>).

sources such as solar energy, wind energy, biogas etc. to power the different devices. As solar energy is abundantly present and can be utilized without any permissions so it is providing the best alternative of all other nonrenewable energy sources. Not only necessarily but also compulsory use of renewable energy sources such as solar energy is the best solution for the energy crisis related problem in Nepal^[1].

Solar energy to run water pumps

Water is necessary for the daily life activities of any living beings. With the periodic development of civilization on the earth the use of water by humans is massive which is also becoming the huge problem as the supply of water is insufficiently fulfilled. And in most places the supply of water is done by running motors from direct electrical grid or from diesels engines motors which is both costly and harmful. That is why a sustaining solution is needed to solve the water crisis in such remote places where there is no facility of direct electrical grid and the use of fossil fuel will be massively expensive. This solar powered water pump can operate throughout the daylight and can deliver water continuously. Since the solar powered energy generation is ecofriendly it is mostly used nowadays. The solar water pump consist solar cell, solar pump, inverter, AC water pumping device etc. Solar energy radiation is converted in electrical current or power source which is then used to run a pump and draw water directly from ground, wells, rivers, lakes etc. The operation of solar powered water pump is more economical than other types of pumping system^[2].

1.2 Rationale

Solar powered water pumps have several advantages over the internal combustion pumps as it does not pollute the environment and also have less maintenance cost. It does not require fuels to operate and it has potential to change the lifestyle of people living under the shade of water crisis for ages. As per the “Global Water Supply and Sanitation Assessment Report” of WHO there are 1.1 billion people around the globe who have not access to pure drinking water and this data was estimated to become 3 billion by 2025^[3]. Thus to control the upcoming water crisis around the globe it is necessary to take action and solve this problem using solar powered water pumps. The SPWP can deliver water as per necessity by use of required size of solar panels because the amount of water that need to be supplied is directly dependent to the size of the PV system and on the size of the pump. A solar panel contains solar cells made up of silicon wafers which is used for fabrication of integrated circuits. Firstly, power is generated on the system using solar Photo Voltaic

array cells. Inverters in the pumping system convert the DC from the solar array into AC. Secondly, a controller works as back up voltage regulator in case if the system is switched off when the voltage is too high or too low. Solar powered water pumps operate throughout the day light as it is directly dependent on the luminosity of the sunlight^[4].

1.3 Solar PV Water Pumping System

There are number of ways of designing solar powered water pumps and among them PV water pumping system is mostly used. Figure 1 shows the generalized representation of solar PV water pumping system^[5]. A solar powered conversion system comprises of PV panels along with the tracking system for improved efficiency which accumulates the solar energy and converts it into electrical energy. Mainly the energy is generated in DC but the pump mostly available in AC so the output energy is needed to be converted to AC by using inverter. And the pumps can be classified on the basis of installation that is either submersible pumps or surface water pumps. It pumps the water from the sources or reservoir to the container or tank installed at some height and thus delivery of water could be easy by the gravity flow^[5,6].

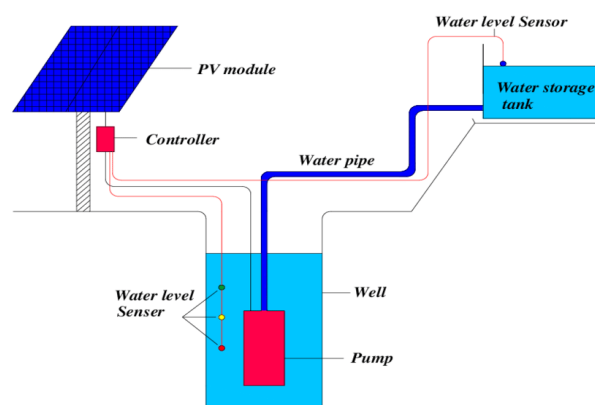

Figure 1. Generalized representation of solar powered water pump

Source: KCP Solar, 2020

This figure shows the schematic representation of solar powered water pump in which solar panel is used along with the controller and submersible pump that pumps water to the storage tank.

1.3.1 Motors

Different types of DC motors like brush, brushless, magnet type and AC motors like induction synchronous are used in solar powered water pumping systems. The proper choice of motor relies on the efficiency of the system, size of the system, price, input power and

availability of the system. DC motors do not need any controller or inverter to convert the DC output, as their output is directly utilized by the system. DC motors are efficient for large applications most likely above 9 hp, but AC motor requires an inverter to convert the DC output of PV array to AC. It requires extra cost and extra energy along with the decrease in efficiency of the system up to some extent due to the use of the inverters. So DC motors are more popular than AC motors due to its high efficiency and performance^[7].

1.3.2 Solar Pump

The type and selection of solar pump is done on the basis of discharge and head of the water. Low lead marine grade bronze and stainless steel are used to manufacture the solar pumps. These pumps are designed such corrosion and maintenance free to work in varying environment with long life span of working. As per application submersible, floating and surface water are the three classification of solar water pumps. The pumps that are installed in deep bore wells are submersible, pumps drawing water from ponds, lake, rivers are surface water pumps and those pumps which floats in the water of the reservoir are the floating water pumps. In submersible and floating water pumps, both the motor and pump are attached in a single unit but they are integrated separately in surface water pump^[8].

1.3.3 Pump Head

The height difference between the water storage tank and water reservoir is the pump head. The pump head is different with the varying capacity of the solar pump. More hp solar pump can lift water from low height to up height more efficiently^[8].

1.3.4 PV Generators

These generators consist of PV module which were connected in series and parallel according to current and voltage required for the operation of water pump along with the running motor. These PV modules consist of PV cells which converts the solar irradiance directly into electrical power. The energy converted from PV cell depends on the climatic condition. It has maximum operating point that is dependent on the irradiance level. During the morning, evening, cloudy and winter season the irradiance level is low due to which a linear current booster is used to match up the current level of the motor^[7,8].

1.3.5 Controllers

During the maintenance and no use condition a circuit

breakers helps to switch off the pumps with the help of controllers. At the required head and flow rate, the pumps require a certain power to deliver certain amount of water. That is why controllers along with the proper PV array size helps to maintain the power in the motor and the pumps^[8].

1.4 Research Objectives

1.4.1 General Objectives

The general objective of solar powered water pump is to pump water from various sources using the available solar energy in efficient manner. Maximum utilization of these freely and abundantly available solar energy to solve the water crisis in different corners of the world is to be its general objectives.

1.4.2 Specific Objectives

This project objectify to study the relationship between the outputs of solar powered pump with the solar irradiance at certain time period. It also specifically aims to study the efficiency of solar powered water pump.

1.5 Contribution of the Study

This project gives the general idea about the solar energy and its possibilities in present world.

It also helps to understand the terms related to solar powered water pump and other devices used to operate the solar water pump.

The correlation between flow rate and solar intensity is observed which shows the efficient operation of solar powered water pump.

This project will enable the researcher to know about Arduino Uno and other materials as well as software used during the research work.

Finally this project gives framework to carry out solar related project in wider sense and carry out project in the field.

2. Literature Review

2.1 Overview of the Subject

Nowadays solar powered water pumping system is widely used all over the world in order to pump water. It is found that the solar energy is the best alternative energy source for several purposes. It is also being used to generate electricity, run several other electronics devices and operate variety of motors efficiently. The use of solar based machines is reliable and easy to maintenance so it is mostly preferred nowadays. It is reliable and less

expensive in long term maintenance cost though its installation cost is high. A simple layman can maintain this solar powered water pumps. The facility of direct conventional power is absent in remote areas of Nepal and also some places where there is facility of direct electrical grid it will cost high to operate motor for desired period of time to fulfill their water need that is why an economical and flexible pumping system is needed to pump water in such backward areas. This technology seems to be very new for many of us but its possibility is being studied from very long period of time about early 1900s^[9].

2.2 Historical Evolution

In 1920 a steam engine was run by using solar energy concentrators to pump water upto a height of 6m by Harrington^[10]. And the first case of solar PV water pump was reported in the Soviet Union in 1964^[11]. Though the flow rate and working head of the water pumping systems were small, but these studies proved milestones in the development of future solar operated water pumping system. Nebraska of Mead in 1977, constructed first large scale PV operated pumping system on an experimental basis. The capacity of this water pumping system was 3.8 m³ per min and could run for 12 hours a day. On the way of its development and method of conversion of solar energy into mechanical energy it was classified in two broad categories- solar thermal and direct conversion schemes. The schemes of direct conversion methods convert solar energy into the electrical energy, which powers the DC/AC motor that in turns operate a pump. It was also found that the thermodynamics conversion were less efficient but requires high maintenance though they were cheaper than direct conversion methods^[12]. Dunford and Ward, studied the technological and economic feasibility and performance of solar powered water pumps under the meteorological conditions of Zimbabwe and found that for borehole, the progressive cavity pumps were most efficient and economical^[13]. Similarly Mankbadi and Ayad, investigated on the technological viability of various types of SPWPS under the meteorological conditions of Egypt. From this technological studies they categorized these SPWPS as solar PV, solar thermal and other solar water pumping methods^[14]. Later on Chowdhury discussed the detail guidelines for SPVWPS and they designed five different SPVWPS of different capacities, for five different places of USA. The performance and reliability of study were carried out for 2 years in which they found that PV power was a cost effective alternative for remote water pumping. And they also concluded that the reliability of PV systems in terms of operation was very good^[15]. All these above

mentioned findings can conclude us to the fact that in the decades of 70-80, the researches and investigations were mainly focused on thermodynamics conversion principle to use the solar energy for water pumping but very few studies were reported on direct conversion principle of using solar energy for water pumping energy source. The technology in solar PV water pumping has been advancing steadily since 1980s. The World Bank executed a UNDP funded project entitled 'Small Scale Solar Powered Pumping Systems' from 1975 to 1983^[16]. This project proved the possibility of solar energy as alternative energy in pumping water efficiently. After the taste of success in this particular project the World Bank extend its funding in several countries for the development of solar powered water pumps. Though the implantation of solar powered water pump increases rapidly, its efficiency and feasibility is doubted for a long time. But further study and experiments done around late 1990s shows the efficiency of this solar powered water pumps to be more than other several fossil fuel powered pumps^[17]. Previously the use of solar powered water pumps was done in small scale to pumps water for household purposes only but from early 2000s the use of such pumps in the development of irrigation project increases. The use of PV pumps was began to irrigate the barren lands around the globe massively^[18]. Solar heater system is developed to heat water using direct solar water pump instead of electric pump and integrated combined system of a photovoltaic thermal solar water heater has also been designed in the year 2008. Solar PV system can also be used in temporary traffic signs, emergency phones, radio transmitters, water irrigation pumps, stream-flow gauges, remote guard post, lightning for roads etc.^[23].

2.3 History of Solar Powered Water Pumping System in the Context of Nepal

A special mechanical valve to pump water is invented in 1968^[19] and is being used as solar powered water pump since then all over the world. The efficiency of solar PV system is about 10% to 23% and its study is being done time to time in order to increase the efficiency and supply the power direct to the grid system.

In the context of Nepal solar energy is in use for various purposes like production of electrical power to fulfill electrical demand of every household in remote areas where there is no facility of direct electrical grid. The first solar powered pumping system was installed in 1993 in Sundharighat, Kathmandu in Nepal, which was a 4 KW system^[19]. And then several project were adopted in subsequent years but not widespread. Around 2015, solar powered pumps evolved as a potential solution for

drinking water and irrigation in several remote areas of Nepal. Several isolated programs installed solar irrigation pumps through Government of Nepal subsidies or grants from the development partners. In 2015, the USAID Accelerated Commercialization solar photovoltaic Water Pumping (AC-SPVWP) was implemented in two phases where the first phase includes 69 SPVWPs in 16 district of terai with combined capacity of 53.15 kWp which benefits 392 farmer groups. And in second phase an additional 120 systems were installed in 2017 [20]. Also International Centre for Integrated Mountain Development (ICIMOD) developed 1.2 KWp – 2.4 KWp solar irrigation project in Bara, Saptari, Sarlahi and Ruatahat districts in Terai [21]. And so many other similar were conducted in several districts of Terai regions. Similarly Gandaki province on Nepal has conducted many solar drinking water project in different remote parts of its different districts like Syangja, Tanahun, Kaski, Myagdi etc. Only in Tanahun districts there are 151 small and large scale solar water drinking project developed by allocating budget of around 270 million. Likewise in recent years Government of Nepal is also promoting solar water project by giving subsidies to similar project all over the country. As per the 15th periodic plan, the GON plans to increase SIPs over 6500 cumulative installation from 2021 to 2024 through Alternative Energy Promotion Centre (AEPCC) [22], but this number may still be less of the total demand.

3. Materials and Methods

1) Initial survey and planning: The initial survey is about pumping techniques and other systems related to this project. So we have to access all the parts and devices necessary to pump water using solar pump.

2) Site visit and case study: Our proposed project site to take data from our prototype device is Kathmandu municipality ward number 16, Balaju. We will be visiting the site and study their water source availability and collect the information about the problems of water at that site. From site visit we gather information about the pumping system existed in that locality.



Figure 2. Balaju industrial area

Balaju industrial area is the reference place of the project experimentation location which is only 50 meter ahead of project location.

In Figure 3, exact location of project experimentation is shown using blue bullet arrow along with the green notation.

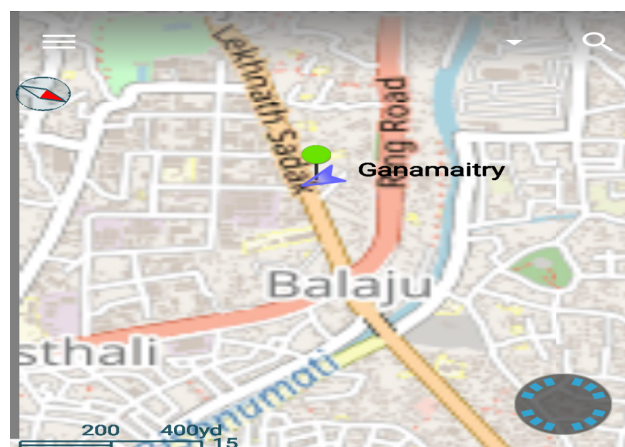

Figure 3. Location of experimentation with the device

3) Collection of information and data: After site visit we have to collect all the necessary information that are needed to perform the solar pump experiment with that prototype device at that site. The previous water source of that site, distance between the community and water source, altitude of water available source, daily consumption of water previously and other possibilities of water usage which are some topic to be highlighted for that site.

3.1 Working of Arduino Based Solar Powered Water Pump

In this research, LDR and LM35 sensors have been used to measure the luminous intensity and temperature respectively. The motor gets DC current from the solar panel and operate to pump water whose flow rate are been sensed by flow sensor. All the measured values from sensors have been received by Arduino Uno. Then the Arduino displays those values in the LCD that is operated from reserved DC source which is shown in Figure 4.

This is the block diagram of solar powered water pump which shows the connection of other hardware with the Arduino Uno device and all the data programmed are displayed in LCD display.

3.2 Software Used in This Research

3.2.1 Arduino Software

To control Sensors and the Arduino, Arduino software is being used, that known as Arduino IDE. In this software it uses a code known as sketch written in C++ and

C++ programming languages. Arduino uses the sketch as a group of instruction to control all the sensors and components connected within it. This software is used in this research in order to write sketch and when the sketch is complete, we upload that to Arduino hardware. Arduino version 1.8.10 is being used in this research which is shown in Figure 5.

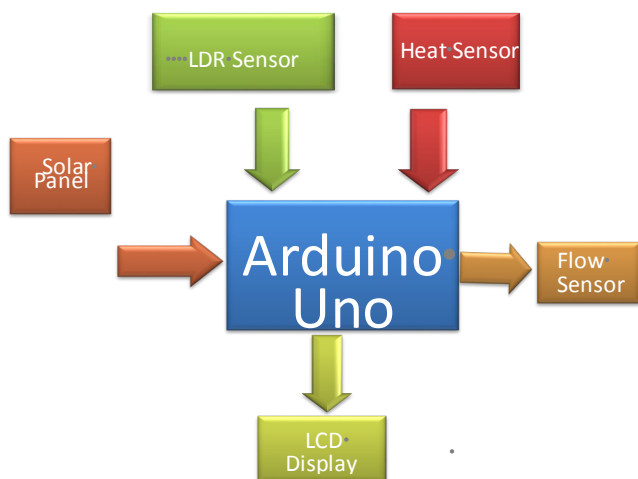

Figure 4. Block diagram of solar powered water pump

This Figure 5 shows the coding works carried out using Arduino Uno software.

3.2.2 Origin Software

It is a computer program for scientific graphing and data analysis produced by Originlab Corporation. This software is used by many physicists, engineers, scientists of commercial industries, academia and government laboratories that is why its users are over half a million globally. It provides an easy interface for beginners, allowing them to make templates for repetitive tasks and to perform batch operations, without the necessity for programming. Several types of data analysis can be done by this software such as polynomial fitting, linear fitting, non-linear fitting, single peak fitting, exponential fitting etc. Generally this software also includes statistical analysis such as descriptive statistics, hypothesis test, ANOVA test, non- parametric test survival test etc. This research uses 8th version of origin software which is shown in Figure 6.

In this figure above, task performed using origin software is shown which performs mainly statistical analysis.

3.3 Circuit Diagram and Working

The circuit diagram of solar powered water pump system is shown in below Figure 7. As shown in the figure, the circuit diagram consists of solar panel, water pump, Arduino Uno along with temperature and light sensor, LCD and flow sensor in systematic order so that a system makes a portable solar powered water pump. A photo voltaic solar panel is connected to the Arduino Uno system in between which a DC water pump is connected which converts the solar energy into mechanical energy and pump water. In order to control the current flow in the Arduino Uno system resistor are connected in both the terminal of the solar panel connecting wires. LM 35 temperature sensor and LDR light sensor are also designed in the Arduino Uno device which measures the value of temperature and luminosity respectively. When the DC pump operates it pump water and in the process water flows from the flow sensor which then measures the flow rate of water. Finally all the measured value of the sensors are displayed in the 16*2 LCD. When light strikes in the solar panel it generates DC current which is used to run the motor and thus pump water through the flow sensor which measure the flow rate in lit/min. LDR light sensor measure the luminous intensity of the sunlight and display the lux value in the IC2 LCD. The LCD displays four data including temperature, flow rate, intensity, voltage offered by solar panel. In such way a solar powered water pump operates by the use of direct sunlight.

In this figure, circuit diagram of the device is shown which consists of solar panel, water pump, LCD display, Arduino Uno along with other sensors.

3.4 Field Observation and Data Collection

Data collected in Balaju area, Kathmandu on 2022/06/08 at around 11AM- 3PM. Figure 8 shows the information about the area of data collection.

Figure 8 shows the location of experimentation (in left) and data collection (in right).

The data collected at this location using device are shown in the Table 1 below.

In Table 1, all the data collected during experimentation are noted respectively in serial wise for different time, intensity, voltage, flowrate, and temperature along with its weather type. In this table weather type is noted by manual observation.

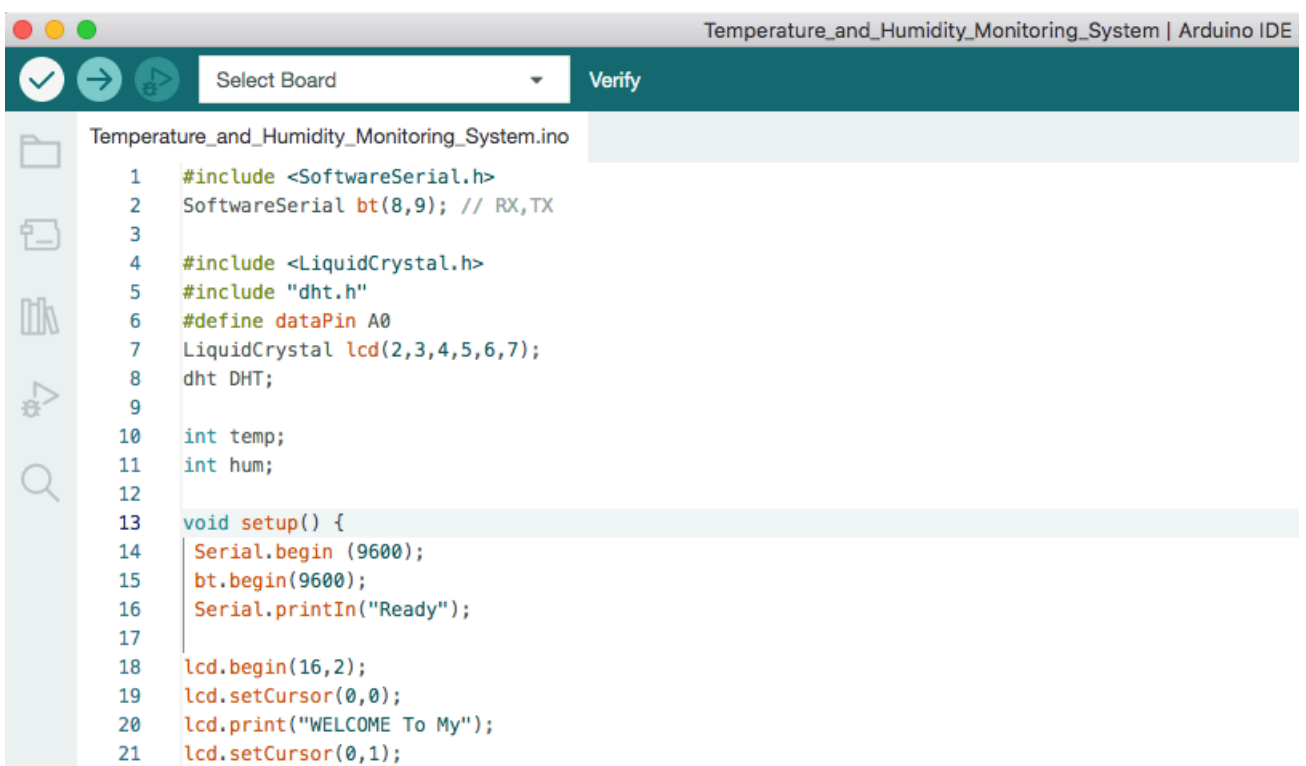

Figure 5. Arduino software

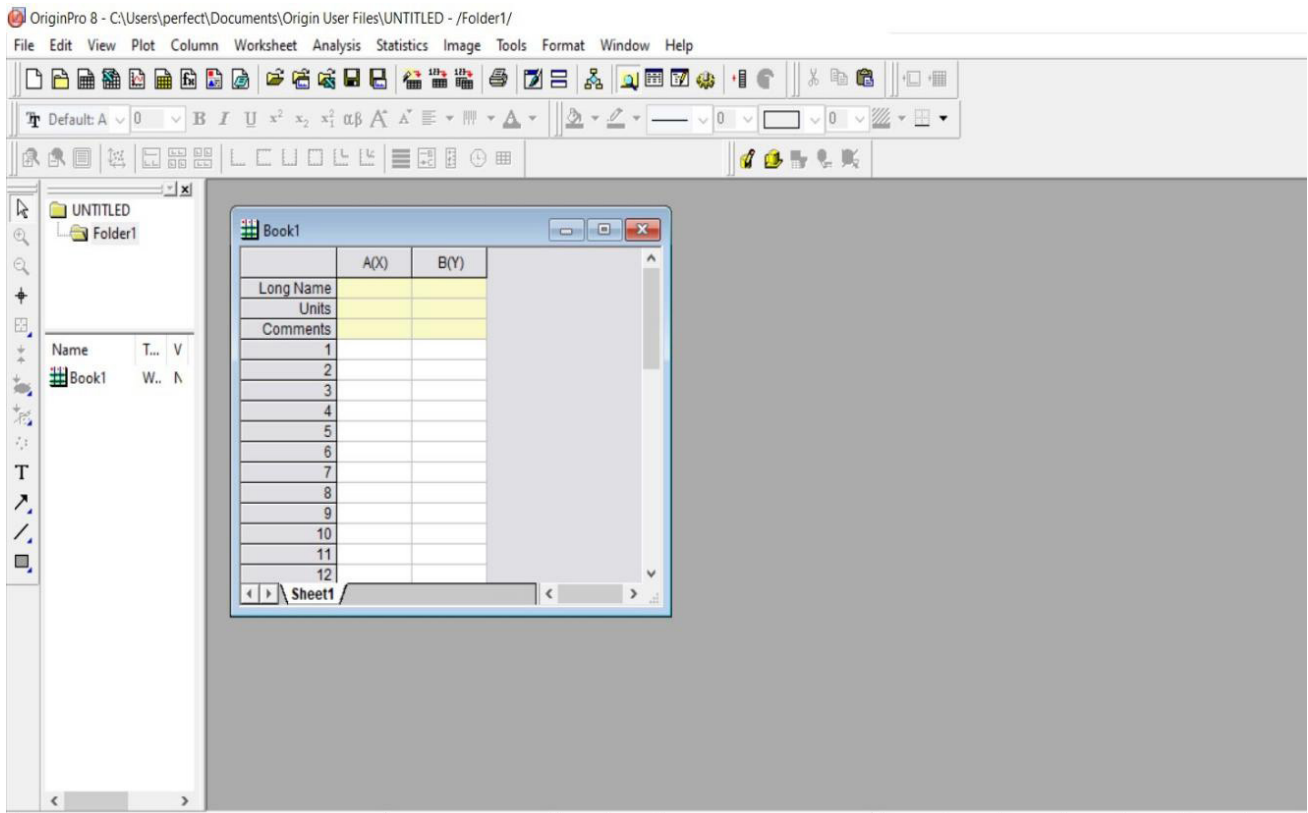

Figure 6. Origin Software

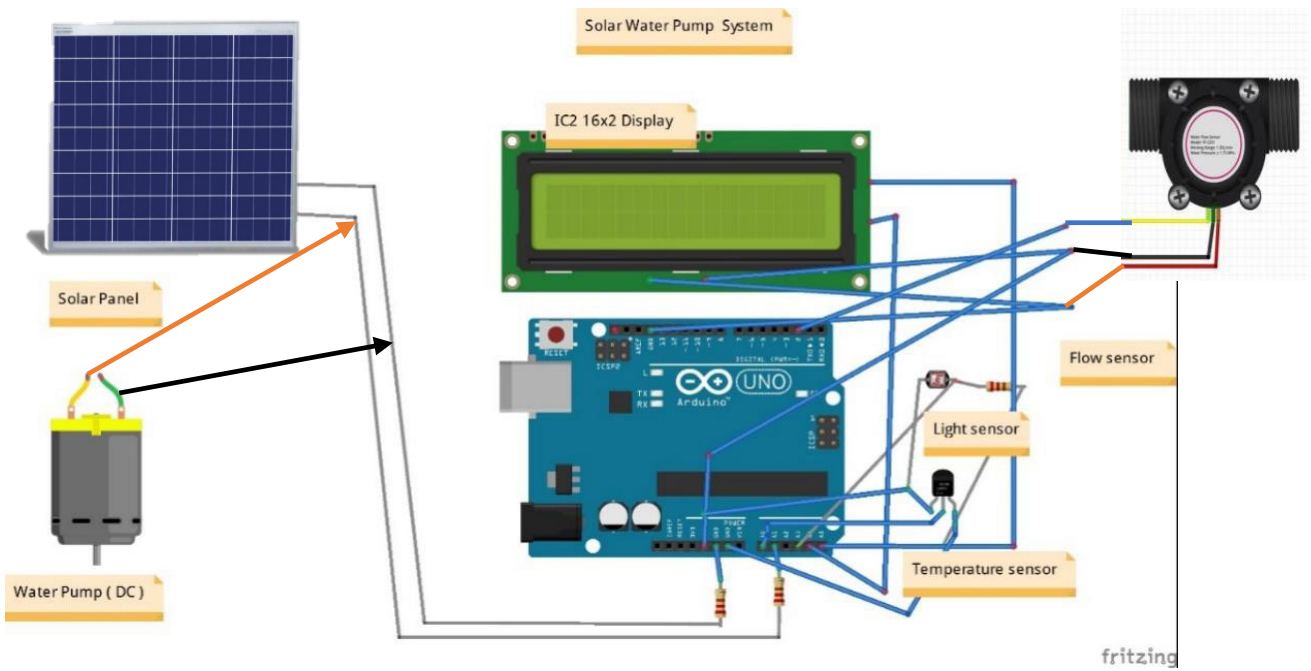

Figure 7. Circuit Diagram

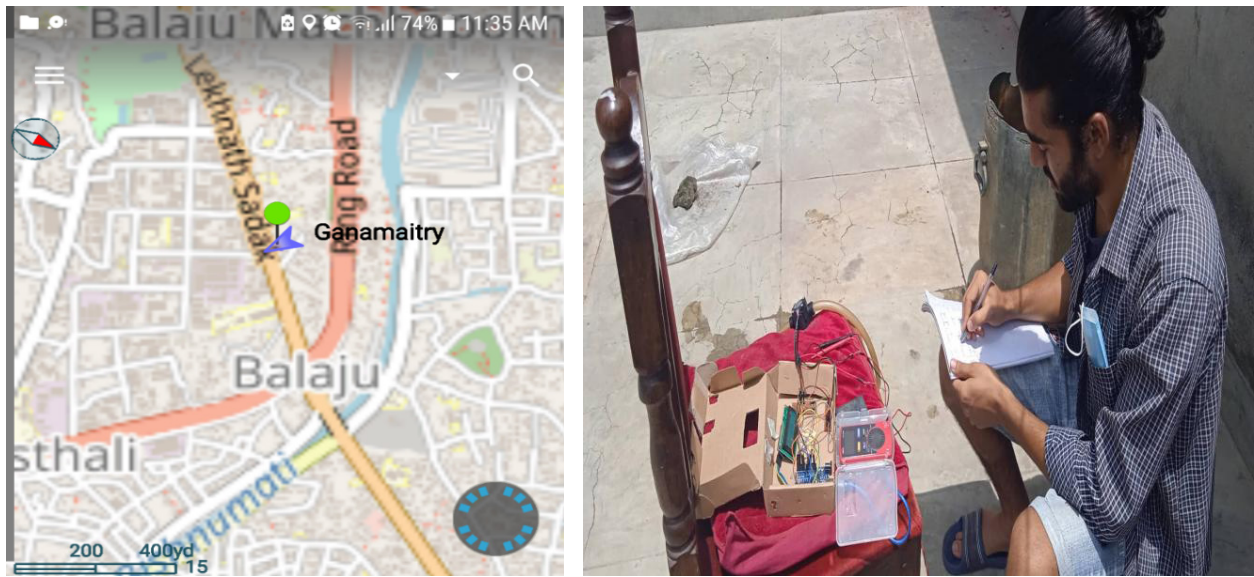

Figure 8. Data collection using device in Balaju area

Table 1. Data collected at Balaju Area using prototype device.

Sn.	Time	Intensity (lux)	Voltage (V)	Temperature in Celsius	Flow rate (L/m)	Weather type
1	11:17AM	1383	19.40	43	0.44	Sunny
2	11:27AM	1338	18.90	39	0.41	Sunny
3	11:37AM	463	18.37	34	0.44	Cloudy
4	11:47AM	1244	19.54	41	0.43	Sunny
5	11:57AM	431	17.88	36	0.29	Cloudy
6	12:07PM	1184	20.03	36	0.40	Sunny
7	12:17PM	590	18.60	33	0.36	Cloudy
8	12:27PM	1088	18.35	42	0.39	Sunny
9	12:37PM	1108	19.60	37	0.42	Sunny
10	12:47PM	329	17.81	32	0.17	Rainy
11	12:57PM	216	17.06	27	0.02	Rainy
12	1:07PM	255	18.00	30	0.14	Rainy
13	1:17PM	292	18.18	29	0.14	Rainy
14	1:27PM	139	18.26	28	0.17	Rainy
15	1:37PM	140	18.32	29	0.25	Rainy
16	1:47PM	189	18.74	31	0.30	Rainy
17	1:57PM	209	19.02	30	0.33	Rainy
18	2:07PM	212	18.80	33	0.41	Rainy
19	2:17PM	508	18.65	38	0.35	Cloudy
20	2:27PM	453	18.65	36	0.33	Cloudy
21	2:37PM	313	17.51	34	0.18	Cloudy

4. Results and Findings

Various types of sensors and component are connected to Arduino Uno with the help of wires. The solar powered pump is constructed using Arduino, solar panel, DC pump, flow sensor etc. the device looks like as Figure 9(a), (b) and (c) below.

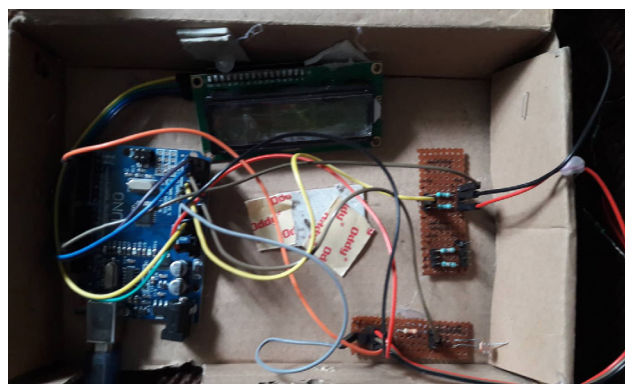

(a)



(b)

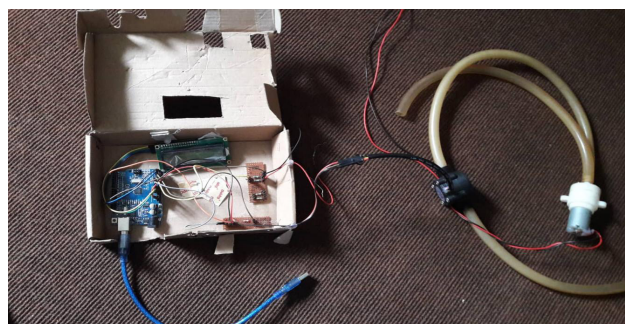

(c)

Figure 9. (a): Arduino Uno connected with LCD and LDR sensor; (b): Input and output of pipe connected with flow sensor and motor; (c): Arduino based system connected with motor and flow sensor

With the help of this prototype device the flow rate of water pumped from direct solar current is observed near Balaju area.

4.1 Results Obtained at Balaju Near Industrial Area

Figure 10 is the location of data collection. The result of analysis of flow rate and luminous intensity has been done in this location is as below.



Figure 10. Location of data collection

(Position: 27.7294° N, 85.3032° E' Latitude: 27.7294° N', Longitude: 85.3032° E', Altitude: 4258ft)

4.1.1 Temperature Data Obtained from the Device

In this location the data are recorded in the morning and afternoon and the following variation of temperature and humidity are obtained in those different phase of time is shown in Figure 11.

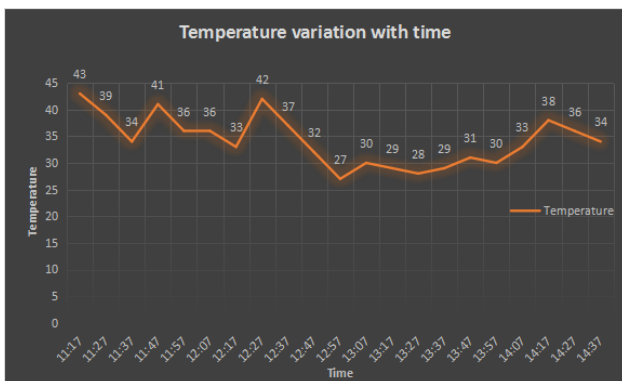

Figure 11. Variation of temperature with time

4.1.2 Intensity Data Obtained from the Device

With the help of Arduino based device analysis has been done in the same location for Luminous Intensity too which is shown in Figure 12.

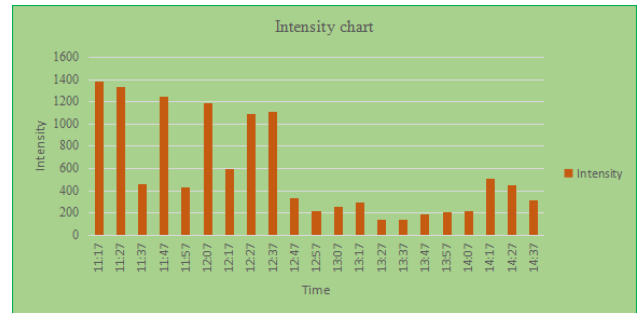

Figure 12. Variation of intensity with time

4.1.3 Flow Rate Data Obtained from Device

Flow rate sensor of the device helps to collect flow rate data at the specific period of time in the unit of liter per minute is shown in Figure 13.

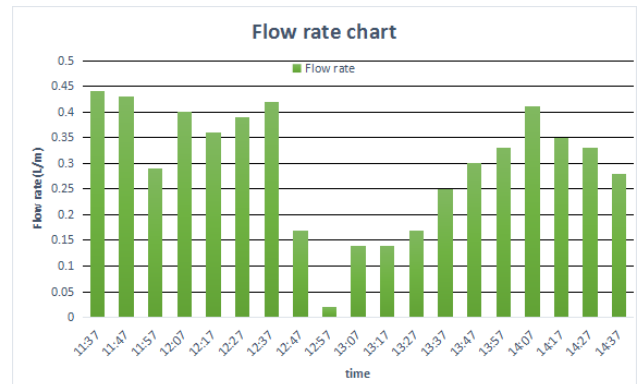

Figure 13. Flow rate of water at different time period

4.1.4 Weather Data from Manual Observation

Weather of the specific period is noted manually using electronic device and also tabulated in Figure 14.

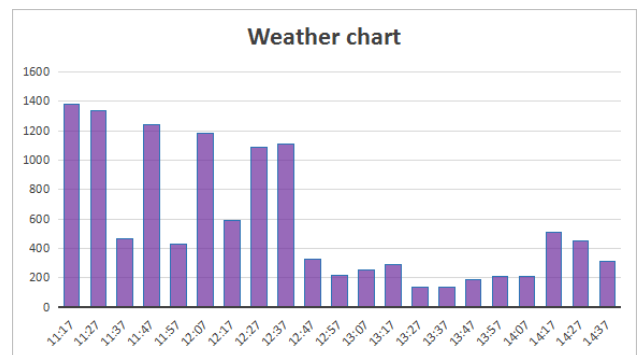

Figure 14. Weather variation with time and intensity.

4.1.5 Voltage Data Obtained from the Device

Voltage offered by the solar panel is displayed in the LCD whose relation with temperature is shown in the curve below in Figure 15.

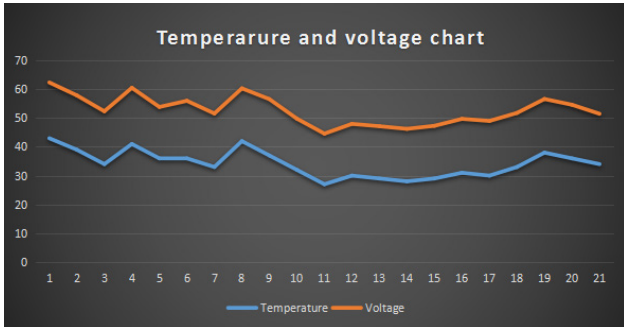

Figure 15. Relation of temperature and voltage

4.1.6 Relation between Voltage and Flow Rate

The rate of flow and the solar panel voltage is shown in Figure 16.

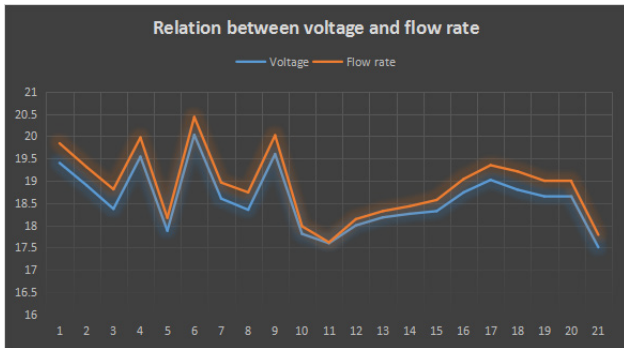

Figure 16. Relation between Voltage and flow rate

4.1.7 Relation between Water Flow Rate with Intensity

The graph of the relation between water flow rate and intensity of sun rays is shown in Figure 17.

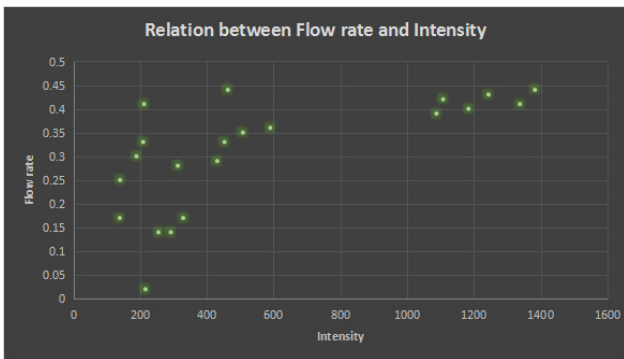

Figure 17. Pattern of water flow with Intensity

4.2 Comparison and Analysis of Data

The analysis of the data obtained from the device is done by linear fitting of the data as shown below.

4.2.1 Linear Fit of Intensity, Voltage, Temperature and Flow Rate with Time Frame

The result of the linear fit of intensity, voltage, temperature and flow rate with time is shown in Figure 18.

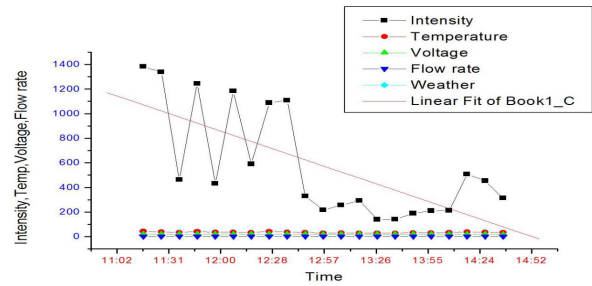

Figure 18. Linear fit of the data obtained from the device

The standard deviation of the values and regression coefficient obtained are as shown in Table 2:

Table 2. Analysis of linear fit of the data using linear regression

S.N.	Parameters	Value	Error	Linear fit equation
1	A	4429.04584	909.89856	$Y = A + B * X$
2	B	-7141.83896	1681.20094	$Y = A + B * X$
3	Regression coefficient	-0.69794	-	-
4	Standard deviation	323.96828	-	-
5.	p-value	4.34935E-4	-	-

4.2.2 Linear Fit of Intensity with Time Frame of the Data

The linear fit of intensity with time is shown in Figure 19 the red color shows the linear fit of the data.

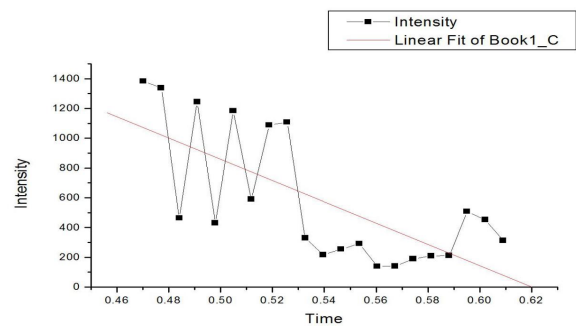

Figure 19. Linear fit of intensity data

4.2.3 Linear Fit of Voltage and Flow Rate over Time Frame

The linear fit of the graph with the parameter of voltage and rate of flow of water is shown in Figure 20.

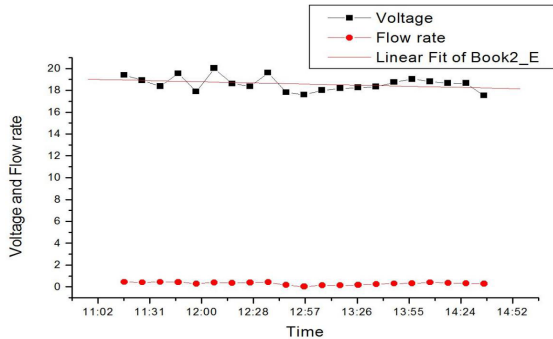

Figure 20. Linear fit of voltage and flow rate data

5. Conclusions and Discussion

In this research, construction and working of solar powered water pump have been explained using Arduino based device to store data. This specially designed solar powered water pump works with three sensors and measures four parameters temperature, solar intensity, water flow rate and voltage offered by solar panel. All setup of the device is done very carefully so that no flaws occur in the data collection. Some sorts of data like temperature, voltage are also noted using handheld device like thermometer and multi meter.

After collecting all the data from the device, the data are interpreted using linear fit model of linear regression. In the above Table 2 the linear fit of the whole parameters is done over time but the linear fit is observed for the intensity data only which shows that there is negative correlation of the parameters as the regression coefficient value is -0.69794 . This observation is quite often because when time passes by the intensity also decreases gradually and during night time pump stops pumping water as there is no presence of any intensity to operate solar panel.

Table 3 is plotted to analyze the difference in regression model of the intensity data when plotted along with all other parameters as in Table 2 and this shows us that there is not any effect of other parameters in the correlation of the intensity data over time. Also we find that the probability value of the data observed is less than the significance level which proves that the relationship observed in the sample also exists for the larger population. From this regression analysis we got to find out that the changes in time also affect the intensity which helps to conclude that non-zero correlation exists in the population.

Table 3. Analysis of linear fit of intensity data using linear regression

S.N.	Parameters	Value	Error	Linear fit Equation
1.	A	4429.04584	909.89856	$Y = A + B * X$
2.	B	-7141.83896	1681.20094	$Y = A + B * X$
3.	Standard Deviation	323.96828	-	-
4.	Regression coefficient	-0.69794	-	-

Also from Table 4 it is seen that the regression coefficient is -0.33196 which helps us to understand that there is negative correlation between the voltage and time frame of the data but the probability value is greater than the significance level and that is why this relation observed in the sample is insignificant for the larger population. This observation helps us to conclude that voltage of the panel is independent with the time frame instead it is dependent on the type and power of solar panel used. It means that the high kilowatt solar panel gives more current and thus more supply of water.

Table 4. Analysis of linear fit of voltage and flow rate data using linear regression

S.N.	Parameters	Values	Errors	Equation
1.	A	21.38065	1.83034	$Y = A + B * X$
2.	B	-5.18774	3.38188	$Y = A + B * X$
3.	Standard deviation	0.65169	-	-
4.	Regression coefficient	-0.33196	-	-

In this way, all the outcomes of this study are as expected since the pattern of the data observed from this prototype device is quite coaxial with the data that can be obtained from the standard devices. So it can be concluded that the project work is successful to meet the objective of studying the relationship between parameters involved in the solar powered water pump.

6. Summary and Recommendation

As so many new technologies are developing in the world day by day, the advancement in the solar device is also inevitable. So in this research something new with the solar powered water pump is done to build up the reliability of the solar pump and develop the usage of solar powered water pump widely.

In this research, solar powered water pump is connected with the Arduino device along with the luminous intensity sensor, water flow sensor, temperature sensor etc. The use of these sensors in this device made it more

informational and precautionary. As we observed from the data and its graphical relation with intensity parameter that flow rate of water is continuous even in the low luminous period of time it can be used throughout the day. This device can be revolutionary in the fulfillment of energy demand in the upcoming future in every field not only in water supply. It can deliver efficient amount of water in the remote part of the villages all over the day time. Nowadays both our neighboring countries India and China are investing huge amount of its national budget in the development of solar plant, solar irrigation and solar energy generation. This also shows the future importance of solar powered devices in the sector of irrigation, city water supply, energy generation etc.

This solar powered water pump provides information about luminous intensity and flow rate of the water at any time. It is easy to operate using portable charging devices like power bank, back up batteries, or even direct from solar current in wider sense. From this research it can be estimated that the use of solar energy is the major solution for the probable energy crisis of future. Thus it is recommended that such type of research regarding the advancement of solar powered water pump should be done in wider aspect to fulfill the water demand of next generation.

The prototype device discussed in this research is more reliable in the sense that it is more informative and portable. This device can be made more efficient by adding some other advanced technology and improving standard of the device that is being used.

Conflict of Interest

There is no conflict of interest.

References

- [1] Kunen, E., Pandey, B., Foster, R., et al., 2015. Solar water pumping: Kenya and Nepal market acceleration. *Solar World COngress* 2015.
- [2] Bhowmik, N.C., et al., 2009. Development of solar water pumping using indigenous technology for irrigation. Research Report, Renewable Energy Research Centre.
- [3] Verma, S., Mishra, S., Chowdhury, S., et al., 2021. Solar PV powered water pumping system—A review. *Materials Today: Proceedings*. 46, 5601-5606.
- [4] Chandel, S.S., Naik, M.N., Chandel, R., 2015. Review of solar photovoltaic water pumping system technology for irrigation and community drinking water supplies. *Renewable and Sustainable Energy Reviews*. 49, 1084-1099.
- [5] Aliyu, M., Hassan, G., Said, S.A., et al., 2018. A review of solar-powered water pumping systems. *Renewable and Sustainable Energy Reviews*. 87, 61-76.
- [6] Meah, K., Ula, S., Barrett, S., 2008. Solar photovoltaic water pumping—opportunities and challenges. *Renewable and Sustainable Energy Reviews*. 12(4), 1162-1175.
- [7] Verma, S., Mishra, S., Chowdhury, S., et al., 2021. Solar PV powered water pumping system—A review. *Materials Today: Proceedings*. 46, 5601-5606.
- [8] Shinde, V.B., Wandre, S.S., 2015. Solar photovoltaic water pumping system for irrigation: A review. *African Journal of Agricultural Research*. 10(22), 2267-2273.
- [9] Sontake, V.C., Kalamkar, V.R., 2016. Solar photovoltaic water pumping system—A comprehensive review. *Renewable and Sustainable Energy Reviews*. 59, 1038-1067.
- [10] Harrington-Lueker, D., 1990. The Engine of Reform Gathers Steam: Kentucky Starts from Scratch. *American School Board Journal*. 177(9), 17-21.
- [11] Sontake, V.C., Kalamkar, V.R., 2016. Solar photovoltaic water pumping system—A comprehensive review. *Renewable and Sustainable Energy Reviews*. 59, 1038-1067.
- [12] Choudhary, P., Srivatava, R.K., De, S., 2017. Solar powered induction motor based water pumping system: A review of components, parameters and control methodologies. 2017 4th IEEE Uttar Pradesh Section International Conference on Electrical, Computer and Electronics (UPCON). IEEE. pp. 666-678.
- [13] Pulfrey, D.L., Ward, P.R.B., Dunford, W.G., 1987. A photovoltaic-powered system for medium-head pumping. *Solar Energy*. 38(4), 255-265.
- [14] Mankbadi, R.R., Ayad, S.S., 1988. Small-scale solar pumping: the technology. *Energy Conversion and Management*. 28(2), 171-184.
- [15] Ramos, J.S., Ramos, H.M., 2009. Solar powered pumps to supply water for rural or isolated zones: A case study. *Energy for Sustainable Development*. 13(3), 151-158.
- [16] Kenna, J., Gillett, B., 1985. Solar water pumping.
- [17] Katan, R.E., Agelidis, V.G., Nayar, C.V., 1996. Performance analysis of a solar water pumping system. In *Proceedings of International Conference on Power Electronics, Drives and Energy Systems for Industrial Growth*. IEEE. 1, 81-87.
- [18] Eker, B., 2005. Solar powered water pumping systems. *Trakia Journal of Sciences*. 3(7), 7-11.
- [19] Shrestha, S., Uprety, L., 2021. Solar irrigation in Nepal: a situation analysis report. Colombo, Sri Lanka: International Water Management Institute (IWMI). pp. 43.

- [20] Bastakoti, R., Raut, M., Thapa, B.R., 2020. Ground-water governance and adoption of solar-powered irrigation pumps: experiences from the eastern Gangetic Plains. IWMI.
- [21] Thapa, B., Scott, C.A., 2019. Institutional strategies for adaptation to water stress in farmer-managed irrigation systems of Nepal. *International Journal of the Commons*. 13(2).
- [22] Wagle, M., 2022. Rs 270m allocated for 151 drinking water projects in Tanahun. <https://thehimalayantimes.com>.
- [23] Dubey, S., Tiwari, G.N., 2008. Thermal modeling of a combined system of photovoltaic thermal (PV/T) solar water heater. *Solar Energy*. 82(7), 602-612.